

IN9319

Hooklock - Cab Door

THANK YOU FOR PURCHASING A VAN GUARD HOOKLOCK

SUITS THE FOLLOWING MODELS

Vehicle:

Vauxhall Vivaro 2014 - 2019
Renault Trafic 2014 onwards
Nissan NV300 2016 - 2021
Nissan Primastar 2022 onwards
Fiat Talento 2016 - 2020

Door:

Cab - Driver's / Passenger's

⊗ Indicates approximate placement of lock

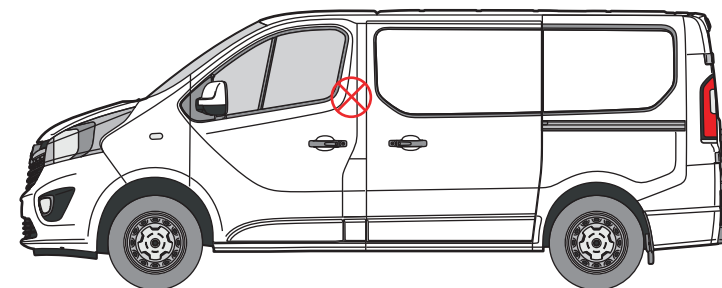
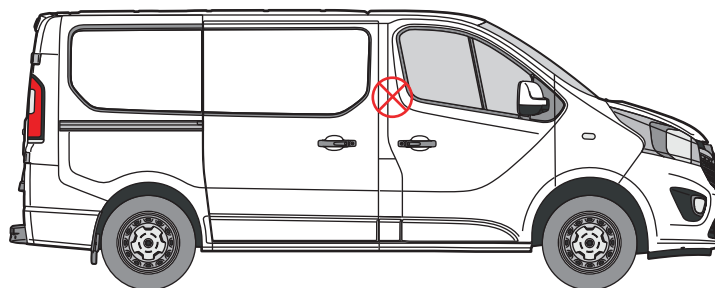

CAUTION

PLEASE TAKE THE TIME TO READ THROUGH THE IMPORTANT INFORMATION BELOW BEFORE PROCEEDING TO FIT THIS PRODUCT



FAILURE TO TAKE NOTICE OF THE FOLLOWING INFORMATION MAY RESULT IN DAMAGE TO THE VEHICLE.

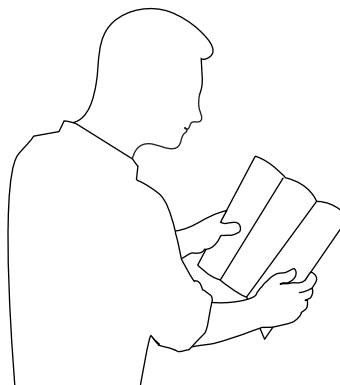

Important: Follow the instructions and all measurements carefully. Double check measurements before making any cuts. Drawings are for guidance only. Every effort has been made to ensure the accuracy of the instructions provided however Van Guard Accessories Ltd accepts no liability for any inaccuracies of either the drawings provided or vehicle variations. All bare metal should be treated with a manufacturer approved anti-corrosion compound and no liability is accepted for any incorrect installation or corrosion to body panels or within cavities. It is the sole responsibility of the installer to ensure the suitability of both the vehicle and of the supplied parts before installation is started. No liability is accepted for the fitting of the products.

This FITTING INSTRUCTION is the property of VAN GUARD ACCESSORIES LTD. and must not be used for manufacturing purposes, copied nor communicated in any way to third parties without written permission from VAN GUARD ACCESSORIES LTD.
IN9319_D (CN:00162)

Van Guard Accessories Ltd
Fair Oak Close, Exeter Airport Business Park,
Exeter, Devon, EX5 2UL
www.van-guard.co.uk

SUPPLIED COMPONENTS

AS3520 X1
(LOCK CASE)



MC9018 X1
(CYLINDER)

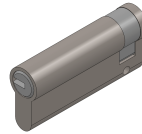

FX4152 X4
(COUNTERSUNK STEEL RIVET - 4.8 X 18)

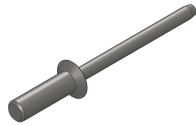

ME3258 X1
(STRIKE PLATE)



FX4155 X2
(ALUMINIUM RIVET - 3.2 X 6)



MA6114 X1
(LOCK CASE GASKET)



FX4159 X1
(COUNTERSUNK SCREW - M5 X 35)

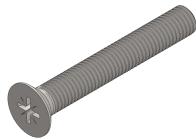

MA6121 X1
(ESCUTCHEON)



Please note that for some products you may have excess components supplied that are not needed for the installation process due to our kitting process.



FAILURE TO TAKE NOTICE OF THE FOLLOWING INFORMATION MAY RESULT IN DAMAGE TO THE VEHICLE.

1. Follow the instructions and all measurements carefully. Double check measurements before making any cuts. Drawings are for guidance only. Every effort has been made to ensure the accuracy of the instructions provided however Van Guard Accessories Ltd accepts no liability for any inaccuracies of either the drawings provided or vehicle variations.
2. All bare metal should be treated with a manufacturer approved anti-corrosion compound and no liability is accepted for any incorrect installation or corrosion to body panels or within cavities.
3. It is the sole responsibility of the installer to ensure the suitability of both the vehicle and of the supplied parts before installation is started. No liability is accepted for the fitting of the products.



Wear the appropriate protective equipment (safety glasses & gloves) while fitting this product.



Dispose of packaging materials responsibly - Do not dispose until you have checked all parts and fixings are present.

1. FITTING THE LOCK CASE

Cut required aperture for lock case using below measurements. **TREAT ALL BARE METAL with a manufacturer approved anti-corrosion compound.** Use a vernier gauge flat against the outside of the cab door to ensure the correct placement of the lock case aperture is achieved.

Note - Images / illustrations show nearside (passengers) cab door, mirror if fitting to a offside (drivers) cab door.



LOCK CASE APERTURE

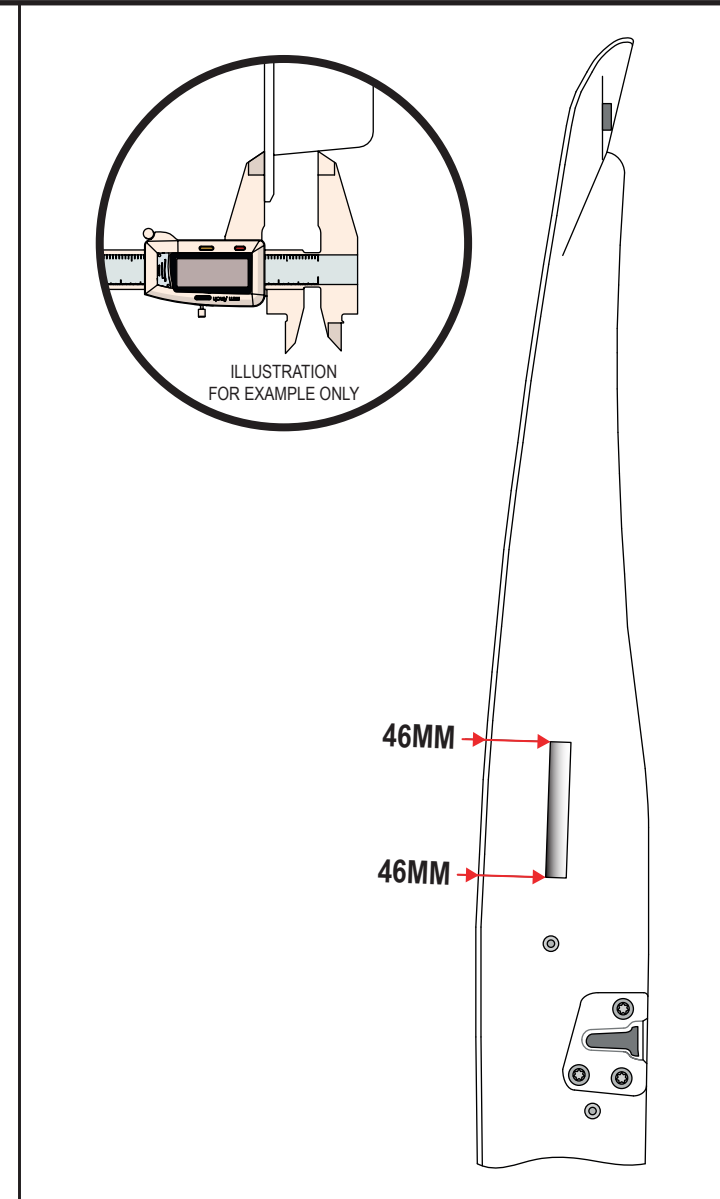
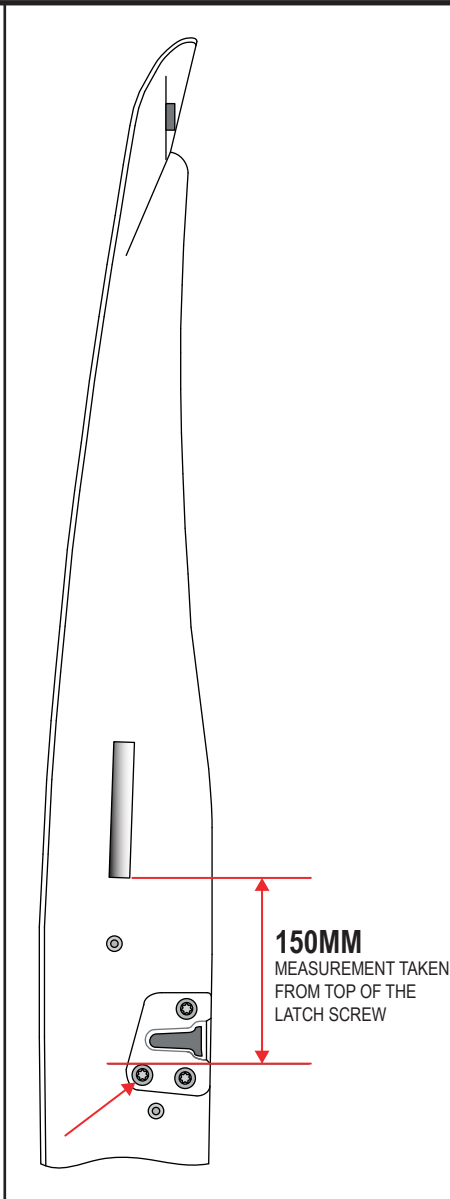
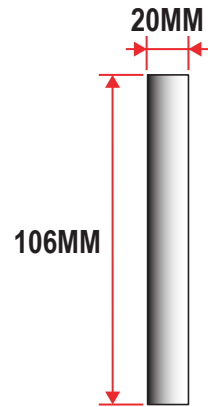

2. CYLINDER ORIENTATION

Important - Cylinders are handed by the orientation of the cam, ensure the cylinder used in the installation is labelled as follows.

Driver cab door = A

Passenger cab door = B

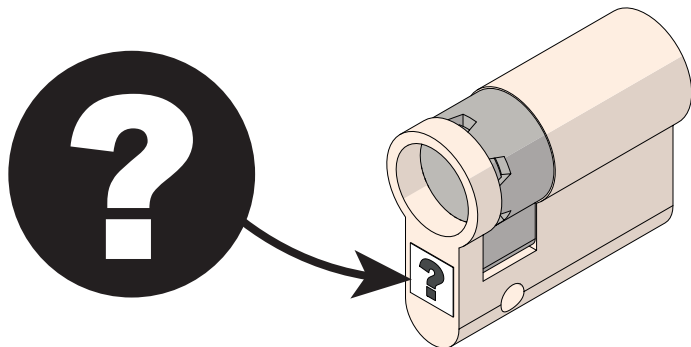

DRIVER CAB DOOR = A

PASSENGER CAB DOOR = B

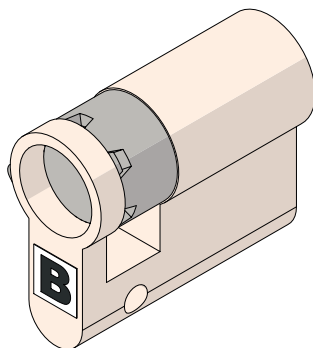
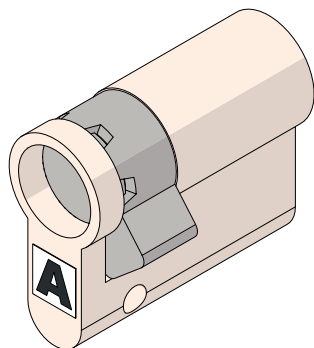
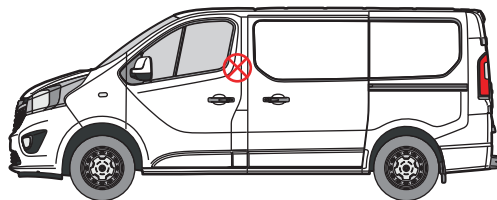
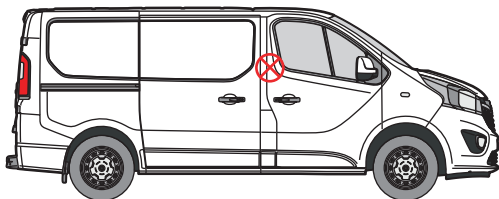

3. CYLINDER POSITION

Use below measurements for placement of lock cylinder and cut aperture accordingly. Ensure cylinder locates with lock case fully and operation is smooth. Do not fully fix in place until the strike plate bracket position has been confirmed (next stage).

Tip: Utilise escutcheon as a template for lock cylinder aperture

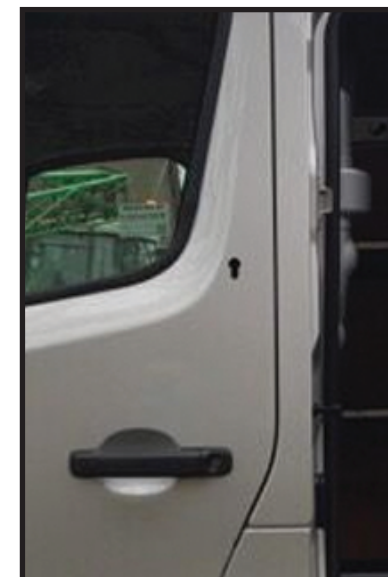
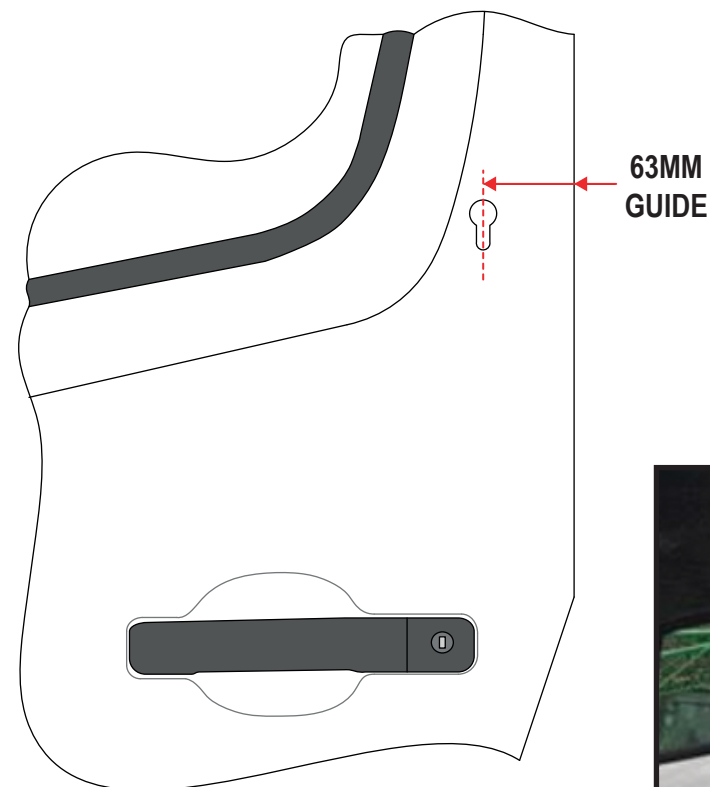

4. FITTING THE STRIKE PLATE

With the lock case and cylinder in place mark the hooklock bolt with grease (or similar). Close the door and actuate the lock. The grease will leave a mark on the receiving body panel guiding where the strike plate bracket is to be fitted.

Once strike plate position is confirmed, use it as a template to mark the aperture which needs cutting. After cutting is complete, hold the strike plate in place with masking tape or similar close the door and actuate the lock again to ensure placement is correct. Move its position if needed. When happy with strike plate position, attach with the supplied fixings.



5. FULLY ATTACH LOCK CASE & ESCUTCHEON

Use supplied fixings to fully fix lock case into position.

Place escutcheon over lock cylinder, mark holes, remove and drill. Secure in place using supplied fixings.

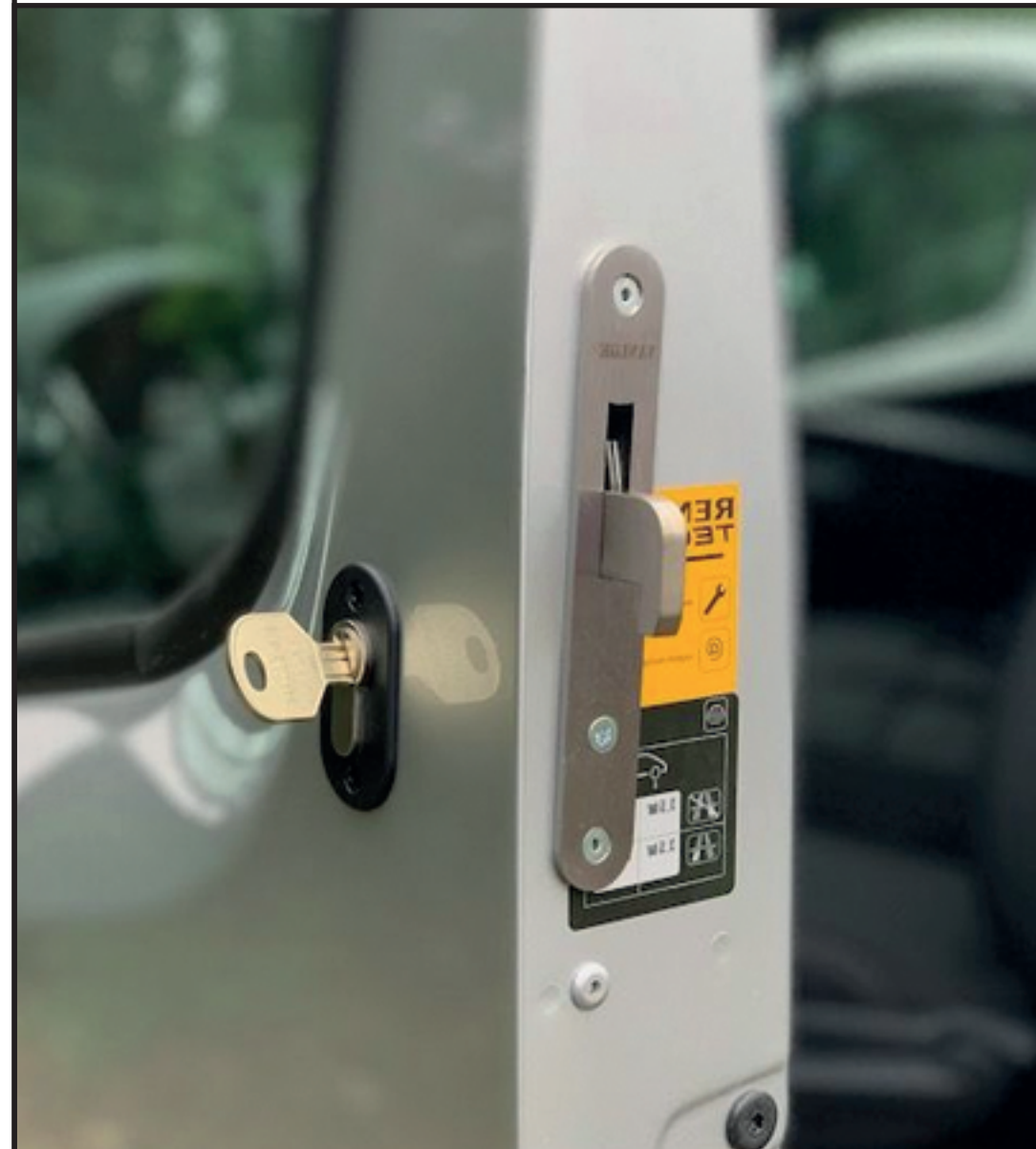

**COMPLY TO UNECE REG 61 AND ITEM 49 OF THE
IVA N1 INSPECTION MANUAL**

FRONT VIEW



SIDE VIEW

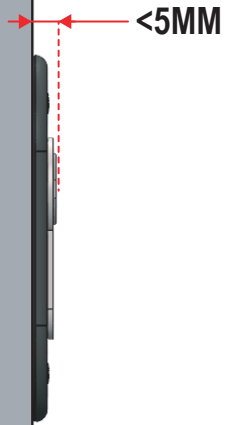

Providing this lock kit is fitted as per instructions, the cylinder will protrude no more than 5mm from the van panel and comply to VCA Type Approval.



BEST FITTING MAINTENANCE

TREAT ALL BARE METAL with a manufacturer approved anti-corrosion compound.

LOCK MAINTENANCE

Regular maintenance of the locks should take place. Using a suitable lubricant will help keep the key and the lock mechanism working smoothly.

COMPLETED NOTE

Depending on the door, the completed lock cylinder and escutcheon may well protrude at an angle. This is normal.