

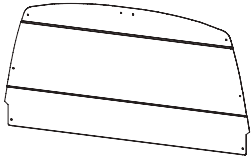



IN8182

Bulkhead

| | | | | | | | |
|---|---|---|--|---|---|--|---|
| VG300S = ME0954 X1 VG301S = ME0956 X1 (TOP)  | VG300S = ME0955 X1 VG301S = ME0957 X1 (BOTTOM)  | ME0958 X1 (BRACKET 1)  | ME0959 X1 (BRACKET 2)  | ME0960 X2 (BRACKET 3)  | ME0961 X1 (BRACKET 4)  | ME0962 X4 (BRACKET 5)  | ME0963 X6 (BRACKET 6)  |
| FX4016 X15 (M6)  | FX4017 X20 (M6)  | FX4020 X5 (M8)  | FX4042 X5 (M6X16)  | FX4061 X10 (M6X14)  | FX4090 X12 (No8 x 1/2")  | FX4091 X3 (No8 x 3/4")  | |

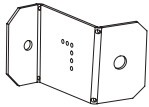
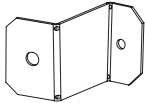
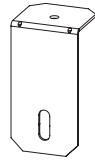
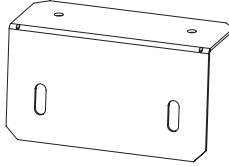
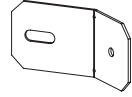
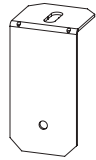
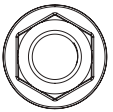
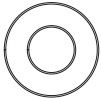
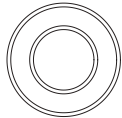
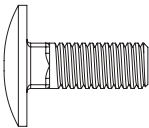
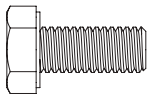
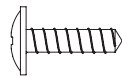
CAUTION - IMPORTANT NOTES

1. You should note that it is the responsibility of the installer/s to ensure that when drilling holes in to your vehicle to take fixings, care must be taken to ensure that the fuel line, tyres, fuel tank, wiring loom, exhaust, bodywork and brake lines etc. are not damaged. Whilst every effort has been made to ensure our products can be safely fitted, changes to vehicles sometimes occur so it's always necessary to check before drilling.

If in doubt refer to the vehicle manufacturer's dealership.



2. When drilling, use as short a drill bit as possible to prevent damage to the vehicle. Use corrosion protection when drilling the vehicle.

3. Wear the appropriate protective equipment (safety glasses & gloves) while fitting this product.

4. Regularly inspect all fixings and parts. Any damaged or worn parts should be immediately removed the vehicle and replaced.

5. Retain instructions for future use. It is important that the end user receives this document.

TOOLS REQUIRED

- SPANNER (10MM) X2

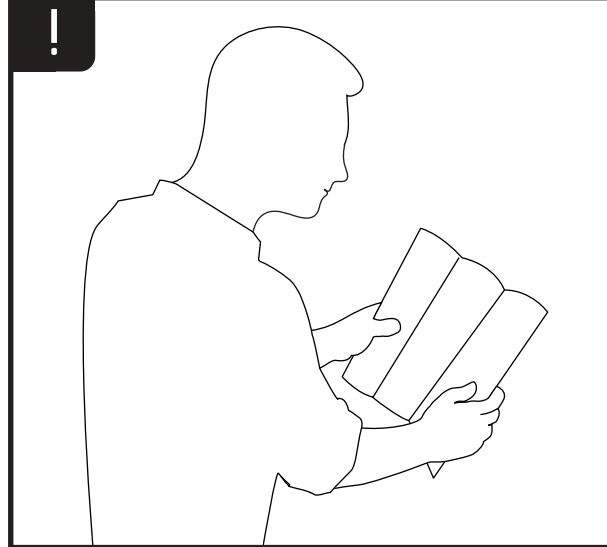
- PH SCREW DRIVER X1

- DRILL (Ø3.2MM) X1

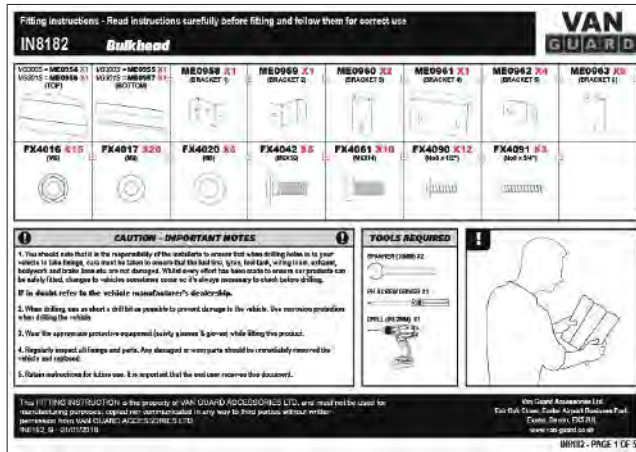

1 Please read the important notes on page 1 before fitting this product.



2 Remove the vehicles ply lined wheel arch covers (if fitted). The covers can be re-fitted once the bulkhead has been fully fitted. Please note that it will be necessary to trim the wheel arch covers for the bulkhead to fit.



3 Loosely secure the top middle bracket (ME0961 / BRACKET 4) to the top half of the top bulkhead using M6x14 hex bolts (FX4061), M6 washers (FX4017) and M6 flange nuts (FX4016).

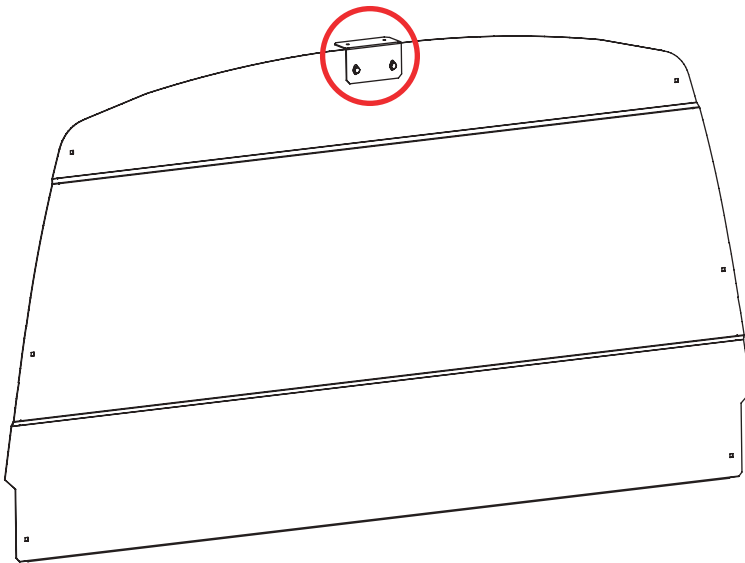

4 Assemble the top and bottom sections together (inside the vehicle) using M6x16 coach bolts (FX4042), M8 washers (FX4020) and M6 flange nuts (FX4016).

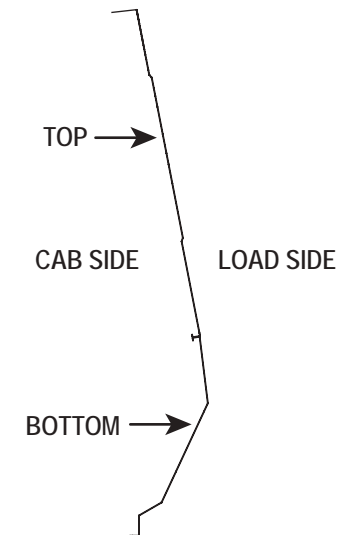
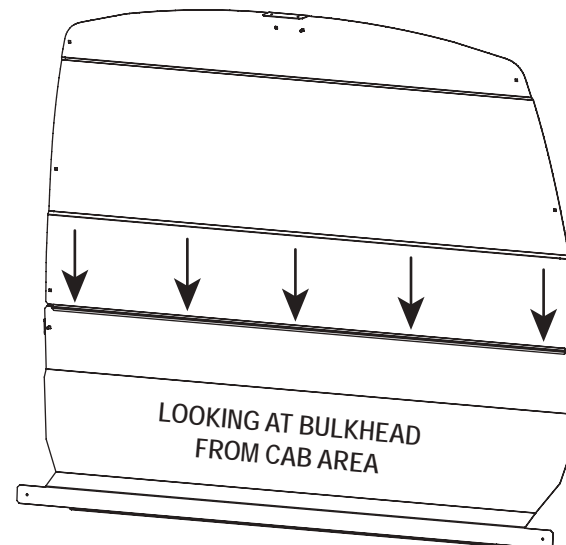

5 Position the bulkhead assembly with the bottom return looking into the cab area and the wings against the vehicles 'C' pillar. Once happy with the position of the bulkhead carefully drill 3.2mm through the fixing holes on the wings and secure to the pillar using No8x1/2" self tap screws (FX4090).

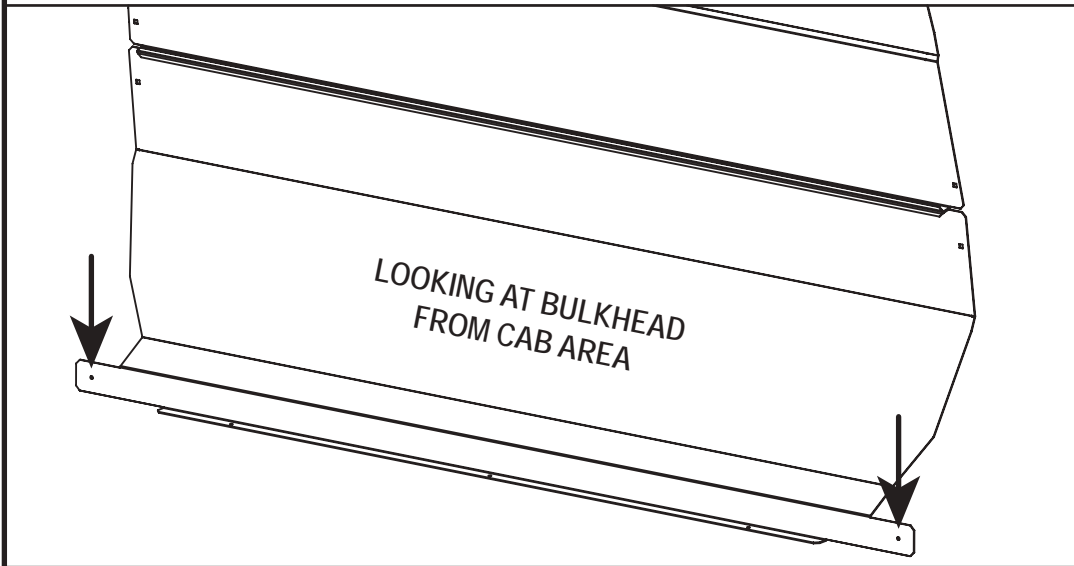

6 Carefully drill 3.2mm through the fixing holes on the bottom return into the floor of the vehicle and secure using No8x3/4" self-tap screws (FX4091).

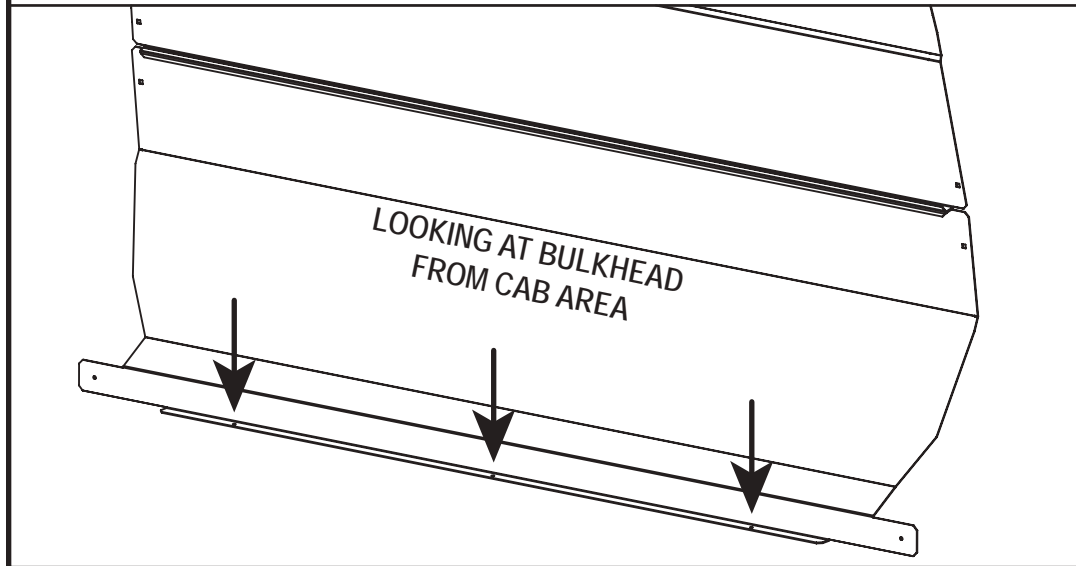

7 Carefully secure the top middle bracket to the double skinned roof support channel using No8x1/2" self-tap screws (FX4090). If the support channel is covered with trim this will need removing.



8 Arrange the remaining fixing brackets so you are familiar with each one.

ME0958 X1
(BRACKET 1)

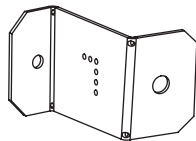

ME0959 X1
(BRACKET 2)

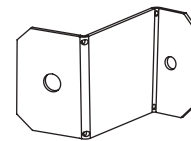

ME0960 X2
(BRACKET 3)

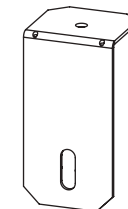

ME0962 X4
(BRACKET 5)

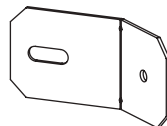

ME0963 X6
(BRACKET 6)

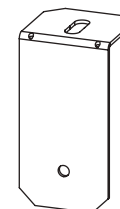

9 IF FITTING TO A VEHICLE WITHOUT PLY LINING

Secure the fixing brackets to the bulkhead using M6x14 hex bolts (FX4061), M6 washers (FX4017) and M6 flange nuts (FX4016). Please note the 'S' brackets (ME0958 & ME0959) are handed. Once happy with the position of the brackets secure to the vehicle using No8x1/2" self-tap screws (FX4090). Once secure tighten all remaining fixings.

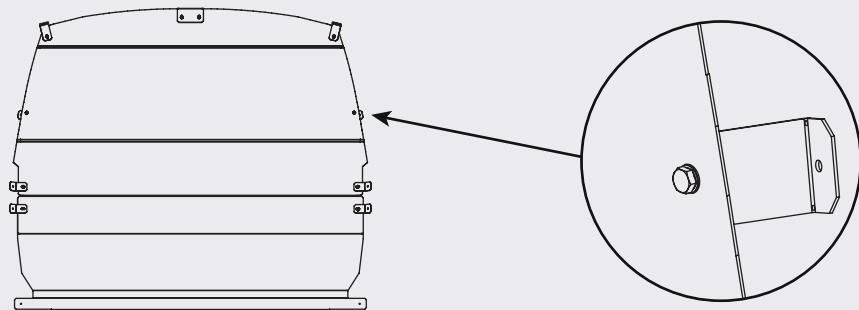
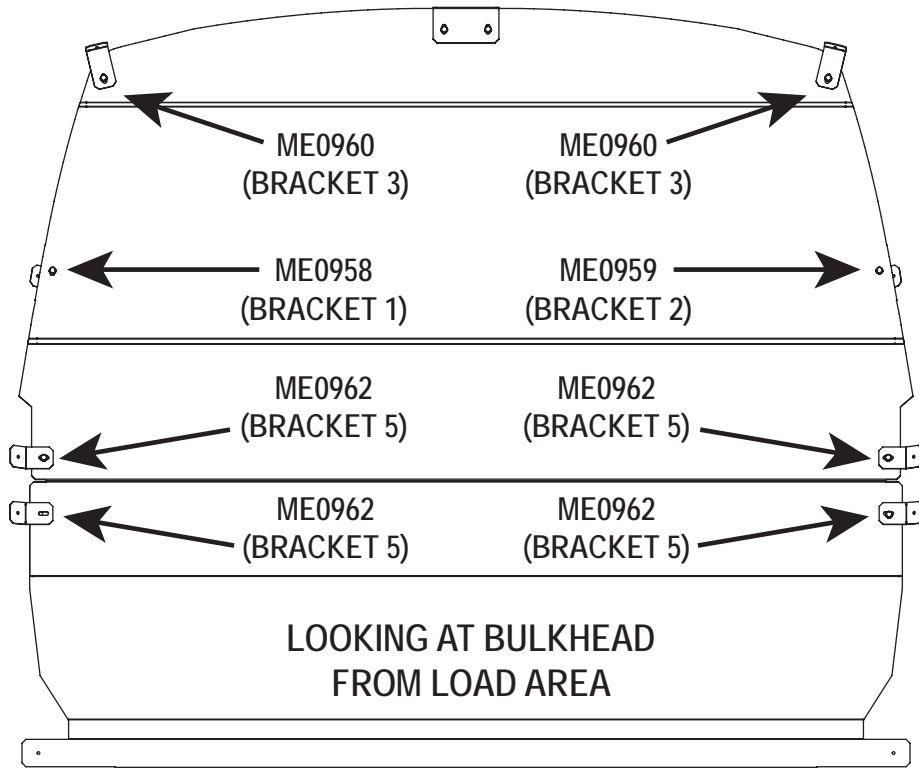

9 IF FITTING TO A VEHICLE WITH PLY LINING

Secure the fixing brackets to the bulkhead using M6x14 hex bolts (FX4061), M6 washers (FX4017) and M6 flange nuts (FX4016). Once happy with the position of the brackets secure to the vehicle using No8x1/2" self-tap screws (FX4090). Once secure tighten all remaining fixings.

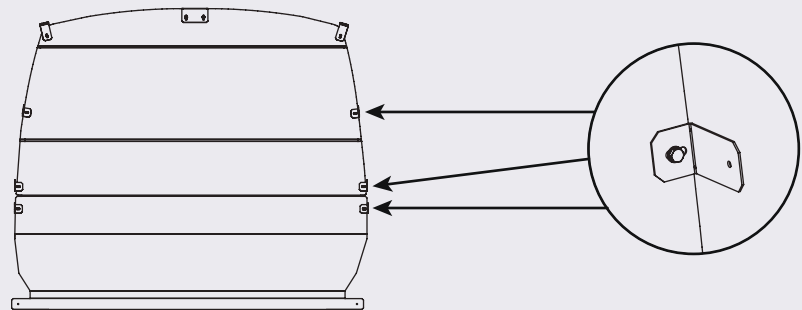
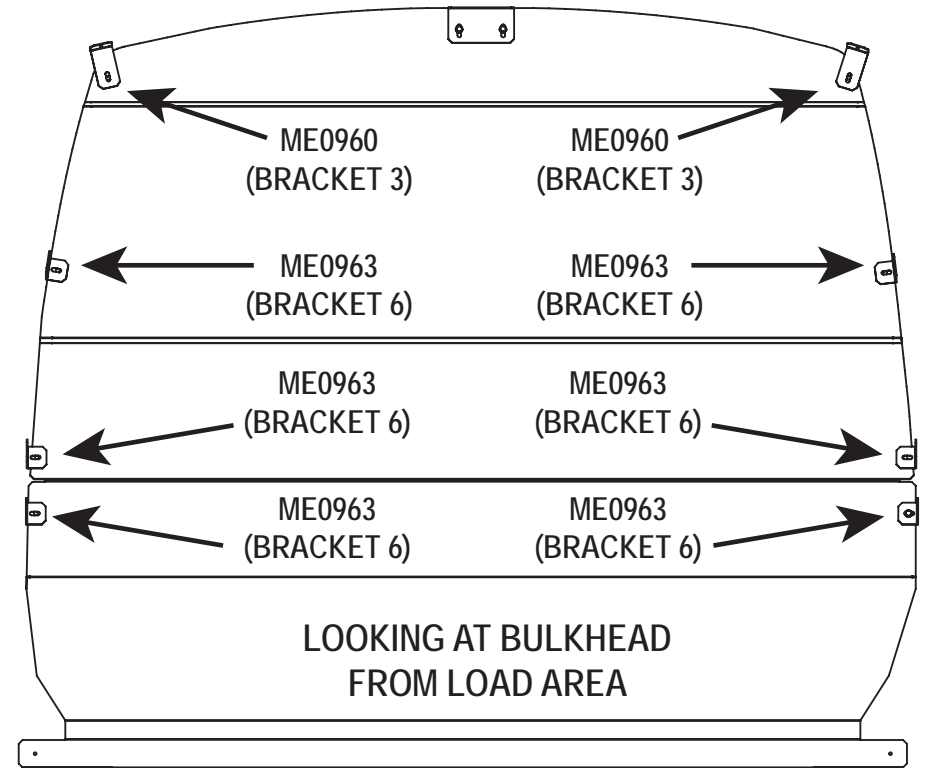

IMAGE SHOWS A VG301 FROM THE CAB SIDE



IMAGE SHOWS A VG300 FROM THE LOAD SIDE



IMAGE SHOWS A VG300 FROM THE CAB SIDE

